

# FREQUENCY EVALUATION OF SPONTANEOUS ACTIVITY IN THE HEART SINOATRIAL NODE

Elena Cocherová

Institute of Electronics and Photonics, FEI STU, Bratislava, Slovakia

## Abstract

The electrical impulses (action potentials, APs) generated spontaneously in the sinoatrial node (SAN) in the heart were modeled in this article. Simulation results revealed that the frequency of APs in the SAN is proportional to value of the  $e$  parameter and  $b$  parameter, and it is inversely proportional to  $c_1$  parameter value.

## 1 Introduction

Electrical signals of the heart are generated in the sinoatrial node (SAN) situated in the right atrium [1], [2]. SAN works as a pacemaker which determines the heart frequency.

Shape of electrical impulses in heart called action potentials (APs) varies in different cardiac cells. Many local models of different types of atrial, ventricular and nodal cardiac cells have been developed on the cellular level [3], [4]. The propagation of electrical activity in the heart can be modeled using models based on reaction - diffusion (RD) equations (e.g. monodomain models) that for local tissue characteristics incorporate the cell models [5], [6].

The physiologically based models, like [4], [7], are capable to model the shape of AP to details, but when they are incorporated into RD spatial model, its numerical is enormously time consuming. The simplified models, like FitzHugh-Nagumo (FHN) model [8], [9], bring solution at acceptable time, but catch only main features of AP shape.

The influence of FHN model parameters on generated AP in SAN was evaluated in this article for both the local and the spatial model of the SAN.

## 2 Description of the FitzHugh-Nagumo Model of the SAN

Membrane potential  $V_m$  in SAN cells can be determined locally using the modified FitzHugh-Nagumo (FHN) [8], [9] ordinary differential equation:

$$\frac{\partial V_m}{\partial t} = -i_{ion} \quad (1)$$

$$\frac{dR}{dt} = k e \left( \frac{V_m - B}{A} - dR - b \right) \quad (2)$$

where

- $i_{ion}$  is the ionic transmembrane current density normalized to  $C_m$
- $R$  is the recovery variable
- $k$  is the membrane-specific parameter
- $e$  is relating to the membrane excitability
- $A$  is the action potential amplitude
- $B$  is the resting membrane potential and
- $C_m$  is the membrane capacity.

The ionic transmembrane current density  $i_{ion}$  can be modeled using the FHN equation:

$$i_{ion} = k c_1 (V_m - B) \left( -\frac{V_m - B}{A} + a \right) \left( -\frac{V_m - B}{A} + 1 \right) + k c_2 R \quad (3)$$

where

- $a$  is relating to the excitation threshold and
- $c_1, c_2$  are the other membrane-specific parameters.

This local model was numerically solved and evaluated in Matlab.

Time and spatial changes of membrane potential  $V_m$  can be modeled by partial differential equation (space model) incorporating the FitzHugh-Nagumo equations (2) - (3):

$$\frac{\partial V_m}{\partial t} = \nabla \cdot (D \nabla V_m) - i_{ion} \quad (4)$$

where the tissue diffusivity  $D$  is dependent on the tissue conductivity  $\sigma$ , the membrane surface-to-volume ratio  $\beta$  and the membrane capacitance per unit area  $C_m$ .

$$D = \frac{\sigma}{\beta C_m} \quad (5)$$

This spatial FHN model defined by Eq. (2) - Eq. (5) was numerically solved in Comsol Multiphysics program.

### 3 Parameters of the FitzHugh-Nagumo Model

The default values for the modified FHN model parameters [8], [9] of the sinoatrial node and the atrial membrane are given in Table 1. Default value of atrial diffusivity incorporated into RD model is set to  $D = 0.0005 \text{ m}^2/\text{s}$ , relating to tissue conductivity  $\sigma = 0.5 \text{ S/m}$  when supposed  $C_m = 1 \text{ }\mu\text{F}/\text{cm}^2$  and  $\beta = 1000 \text{ cm}^{-1}$ , while nodal conductivity and diffusivity is taken 10 times smaller. The default initial values of membrane potential  $V_m$  and recovery variable  $R$  are given in Table 1.

The membrane potential  $V_m$  generation and propagation was computed using a slab model of size  $20 \times 20 \times 4 \text{ mm}$  (Fig. 1) representing atrial tissue, in which is in the middle situated SAN. Geometry of SAN is modeled as semisphere of  $2 \text{ mm}$  radius.

Table 1: DEFAULT PARAMETERS VALUES FOR THE MODIFIED FHN MODEL [8], [9]

	<i>Default Parameter Values</i>	
	<i>SAN Tissue</i>	<i>Atrial Tissue</i>
$a$	-0.6	0.13
$b$	-0.3	0
$c_1$	1000	2.6
$c_2$	1	1
$d$	0	1
$e$	0.080	0.0132
$A$	0.033 V	0.120 v
$B$	-0.022 V	-0.085 V
$k$	1000 1/s	1000 1/s
$V_0$	-0.035 V	-0.085 V
$R_0$	-3.7	0.1
$D$	0.00005 $\text{m}^2/\text{s}$	0.0005 $\text{m}^2/\text{s}$

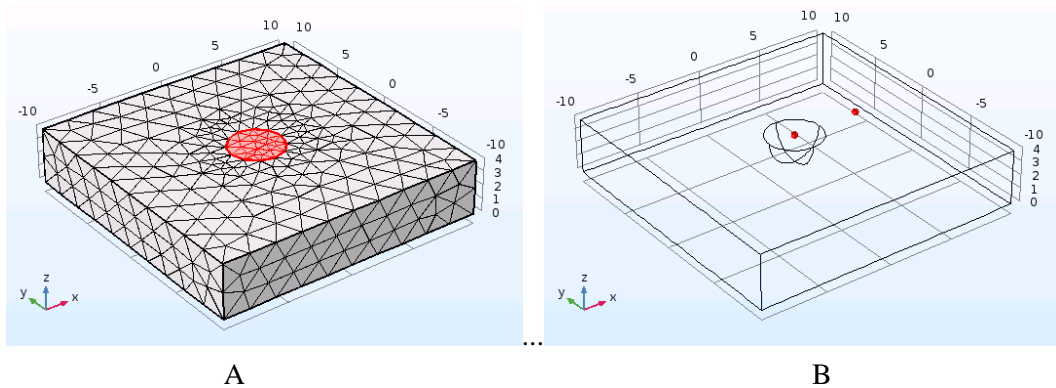

Figure 1: (A) The generated mesh of the slab model of the atrial heart wall with the SAN in the middle (red color). (B) The position of the points (red dot) from which data were taken. The axes are in mm.

## 4 Results

An example of spatial distribution of membrane potential  $V_m$  at time  $t = 15$  ms in the SLAB model obtained from numerical solution in Comsol Multiphysics for default values of FHN parameters is shown in Fig. 2.

Time courses of the membrane potential  $V_m$  and recovery variable  $R$  solved numerically in the spatial RD model (slab) are shown in Fig. 3 and Fig. 4. APs in atrial tissue were triggered by APs spontaneously generated in SAN (pacemaker of the heart).

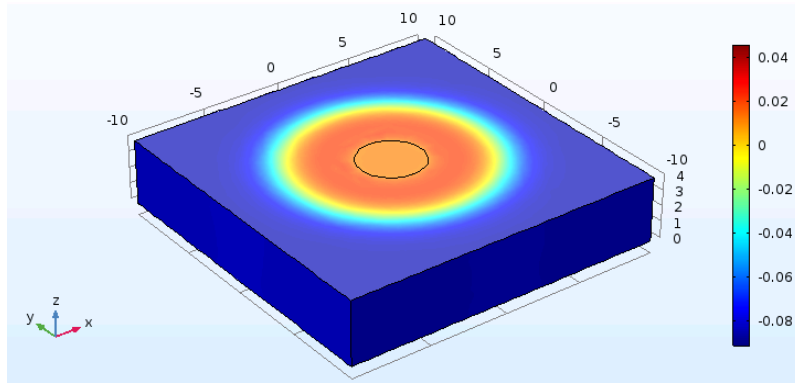

Figure 2: Spatial distribution of membrane potential  $V_m$  (in volts) at time  $t = 15$  ms in the slab model.

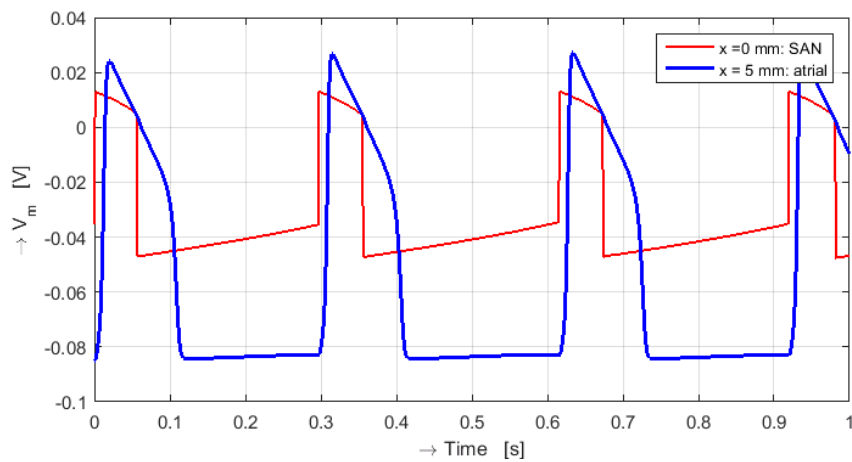

Figure 3: Time courses of the membrane potential  $V_m$  at  $x = 0$  mm (SAN) and at  $x = 5$  mm (atrial tissue) in the slab model.

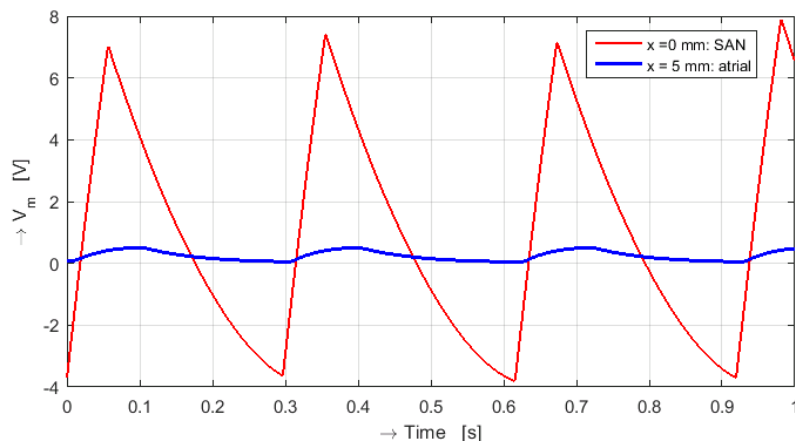

Figure 4: Time courses of recovery variable  $R$  at  $x = 0$  mm (SAN) and at  $x = 5$  mm (atrial tissue) in the slab model.

Time courses of the membrane potential  $V_m$  solved numerically in the local model in Matlab for various values of the  $e$  parameter are shown in Fig. 5. Solution for the same values of the  $e$  parameter solved in the spatial RD model (slab) in Comsol Multiphysics is shown in Fig. 6. Frequency of SAN increases with the increase of the  $e$  parameter value.

Solution of the local and the spatial model was compared for the value of the parameter  $e = 0.160$  in Fig. 7. As it is shown, the frequency of SAN is slightly higher in the spatial model.

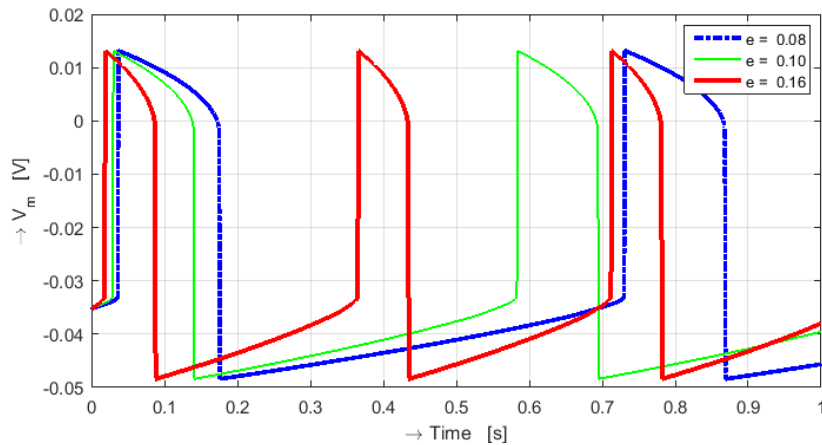

Figure 5: Time courses of the membrane potential  $V_m$  for various values of the  $e$  parameter in the local model in Matlab.

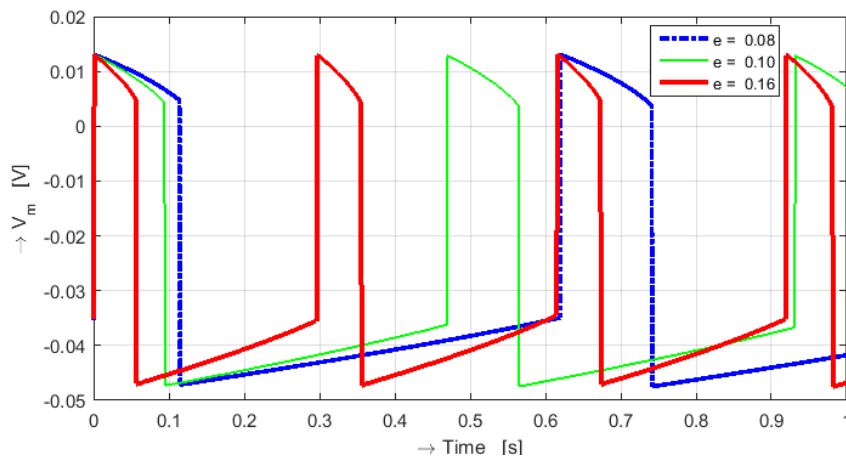

Figure 6: Time courses of the membrane potential  $V_m$  for various values of the  $e$  parameter in the slab model.

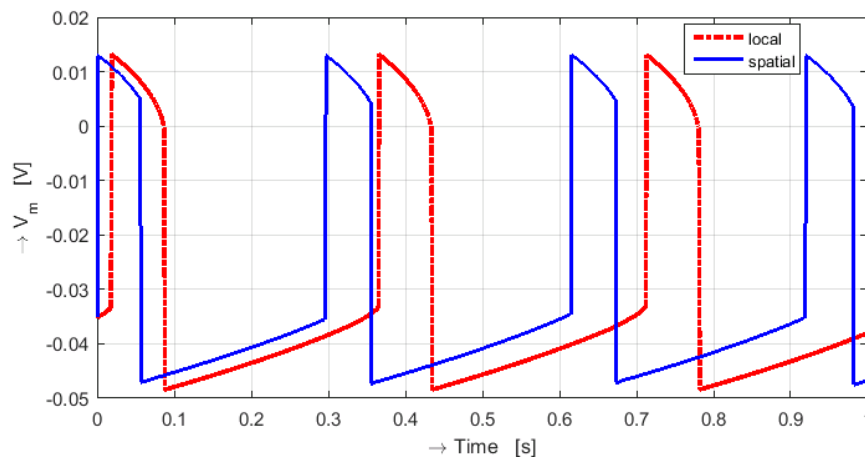

Figure 7: Time courses of the membrane potential  $V_m$  in the local and spatial model for  $e = 0.160$ .

Time courses of the membrane potential  $V_m$  solved numerically in the local model in Matlab for various values of the  $b$  parameter and  $c_1$  parameter are shown in Fig. 8 and Fig. 9, respectively.

Frequency of heart determined by the frequency of SAN increases with the  $b$  parameter value increase and decreases with the  $c_1$  parameter value increase.

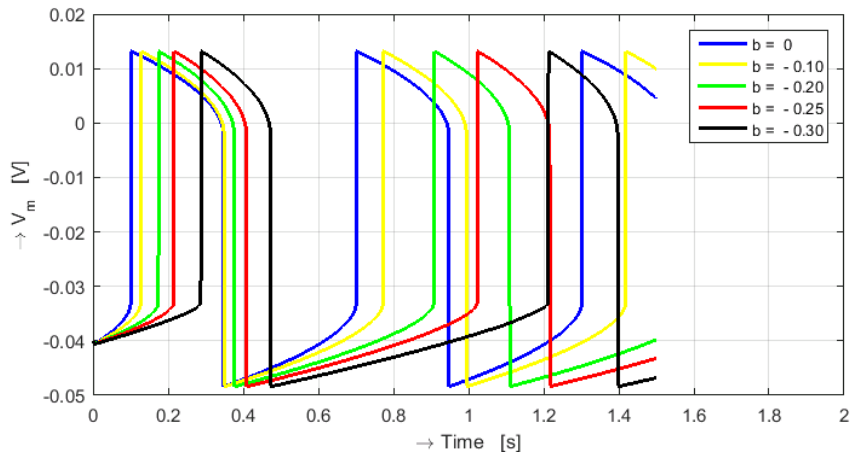

Figure 8: Time courses of the membrane potential  $V_m$  for various values of the  $b$  parameter in the local model ( $V_0 = -0.040$  V,  $R_0 = -1$ ).

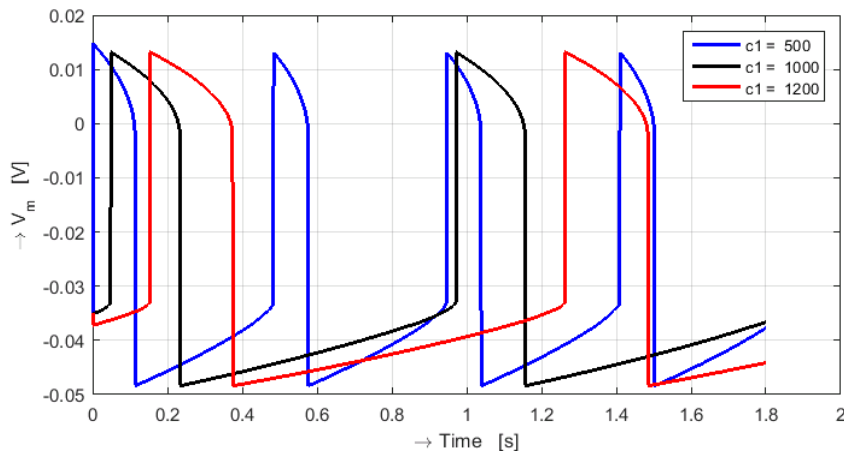

Figure 9: Time courses of the membrane potential  $V_m$  for various values of the  $c_1$  parameter in the local model ( $V_0 = -0.035$  V,  $R_0 = -3.7$ ).

## 5 Conclusion

In the article, the spontaneous electrical activity generated in the SAN in the heart was modeled. Frequency of SAN increases as the  $e$  parameter and  $b$  parameter increases, while the SAN frequency decreases with the increase of the  $c_1$  parameter value. It was shown from simulation results that the frequency of SAN is slightly higher in the spatial model than in the local one.

## Acknowledgement

The work has been supported by the Ministry of Education of Slovak Republic under the KEGA 037UK-4/2016. Author thank to CVTI for supplying of the COMSOL Multiphysics and MATLAB programs.

## References

- [1] P. W. Macfarlane, A. Van Oosterom, O. Pahlm, P. Kligfield, M. Janse, J. Camm. *Comprehensive electrocardiology*. Springer-Verlag, London, 2011, ISBN 978-1-84882-046-3.
- [2] J. P. Boineau, T. E. Canavan, R. B. Schuessler, M. E. Cain, P. B. Corr, J. L. Cox. *Demonstration of a widely distributed atrial pacemaker complex in the human heart*. *Circulation*, vol. 77, no. 6, pp. 1221-1237, Jun, 1988.
- [3] D. Noble, A. Garny, P. J. Noble. *How the Hodgkin-Huxley equations inspired the Cardiac Physiome Project*. *Journal of Physiology-London*, vol. 590, no. 11, pp. 2613-2628, Jun, 2012.
- [4] R. Wilders. *Computer modelling of the sinoatrial node*. *Medical & Biological Engineering & Computing*, vol. 45, no. 2, pp. 189-207, Feb, 2007.
- [5] A. J. Pullan, L. K. Cheng, M. L. Buist. *Mathematically modelling the electrical activity of the heart: from cell to body surface and back again*. World scientific, Singapore, 2005, ISBN 981-256373-3.
- [6] M. Potse, B. Dube, J. Richer, A. Vinet, R. M. Gulrajani. *A comparison of monodomain and bidomain reaction-diffusion models for action potential propagation in the human heart*. *IEEE Transactions on Biomedical Engineering*, vol. 53, no. 12, pp. 2425-2435, Dec, 2006.
- [7] A. O. Verkerk, R. Wilders. *Pacemaker activity of the human sinoatrial node: effects of HCN4 mutations on the hyperpolarization-activated current*. *Europace*, vol. 16, no. 3, pp. 384-395, Mar, 2014.
- [8] E. Cocherová. *Analysis of the activation propagation velocity in the slab model of the cardiac tissue*. In: *Measurement 2015 : 10th International Conference on Measurement*, May 25 - 28, 2015, Smolenice, pp. 105-108.
- [9] S. Sovilj, R. Magjarevic, N. H. Lovell, S. Dokos. *A Simplified 3D Model of Whole Heart Electrical Activity and 12-Lead ECG Generation*. *Computational and Mathematical Methods in Medicine*, pp. 10, 2013.

---

Elena Cocherová

Institute of Electronics and Photonics, FEI STU, Ilkovičova 3, 812 19 Bratislava, Slovakia

elena.cocherova@stuba.sk